

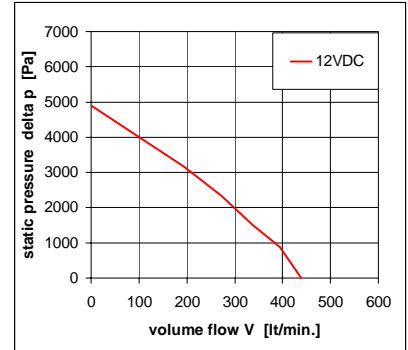

Miniatur Radial Gebläse  
Miniature Radial Blower  
Ventilateur miniature radial



U51DX-012KK-5 12VDC



U51DX-024KK-5 24VDC

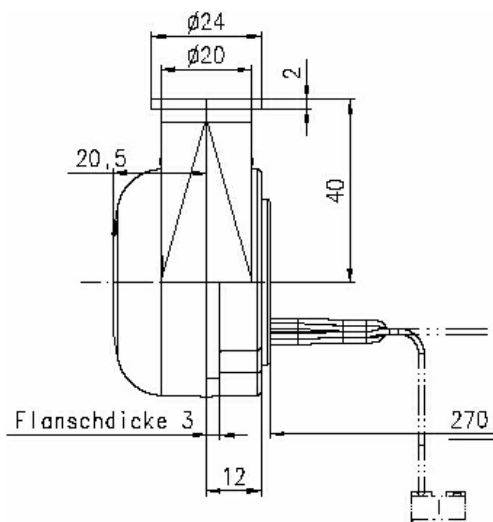
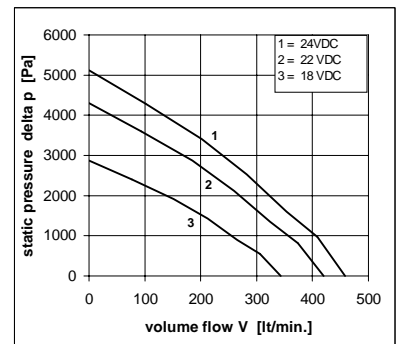

nsaug  
nlet

Ausblas  
Outlet

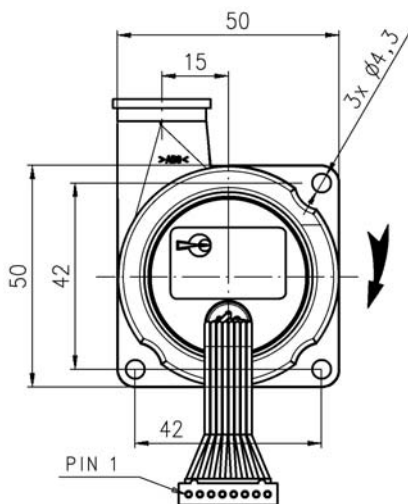
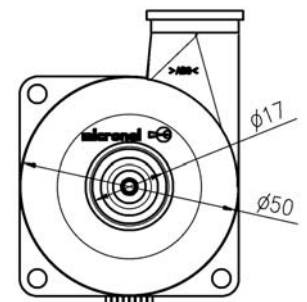
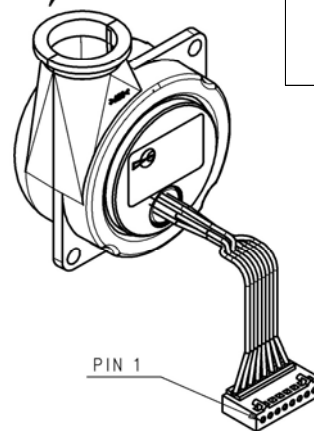

Steckerbelegung / connector pin assignment:

brown	Motorwinding 1	PIN 1
red	Motorwinding 2	PIN 2
orange	Motorwinding 3	PIN 3
yellow	Vhall 4.5...18 V DC	PIN 4
green	GND	PIN 5
blue	Hall sensor 1*	PIN 6
violet	Hall sensor 2*	PIN 7
grey	Hall sensor 3*	PIN 8

\* internal Pull-up (7...13 kohm) to Pin 4

## Technische Daten

## Technical data

## Caractéristiques techniques

### Motor

Bürstenloser 3-Phasen Motor (mit Hallsensoren) ohne integrierte Elektronik (externe Elektronik nötig)

Standardluftdichte 1.2kg/m<sup>3</sup>

### Motor























Brushless 3-Phasen motor (with hall sensors) without integrated motor controller (external driver required)

Standard air density 1.2kg/m<sup>3</sup>

### Moteur

Moteur à 3 phases, sans brosses (avec hall sensor) sans électronique intégré (électronique externe indispensable)

Densité de l'air standard 1,2 kg/m<sup>3</sup>

			U51DX-012KK-5	U51DX-024KK-5
	U <sub>N</sub>	V	12	24
	U	V	8.0-12.5	12.0-24.0
	I <sub>N freeblowing</sub>	mA	2'619	1'416
	I <sub>N work. point</sub>	mA	2'575	1'408
	I <sub>N static</sub>	mA	1277	684
	I <sub>block</sub>	mA		
	P <sub>N work. point</sub>	W	30.90	33.80
	n freeblowing	min <sup>-1</sup>	40'472	42'180
	n work. point	min <sup>-1</sup>	40'678	42'250
	n static	min <sup>-1</sup>	48'193	49'590
	V freeblowing	l/min	439	458
	V work. point	l/min	272	283
	p work. point	Pa	2344	2'530
	p static	Pa	4'906	5'120
	LpA (WP)	dB(A)	62	62
	MTTF (WP)	hr	20'000 / 25°C at 30'000 rpm	
	T	°C/°F	-20...+40 / -5...+105	
	m	gr/oz	90 / 3.17	
	Leads	mm/inch	270 / 10.6 (AWG24) / Connector Stocko MKFL 13268-6-0-808	
	Housing Material		ABS UL-94HB	
	Sleeve Bearing		N/A	N/A
	Ball Bearing		•	•
	Tacho		•	•

Data's of Blower were measured with control board H015X-522A9